

SECCIÓN ENTRE CORRIENTES Y LAVALLE - TÚNEL

SECCIÓN LAVALLE - SECCIÓN ESPECIAL / TÚNEL

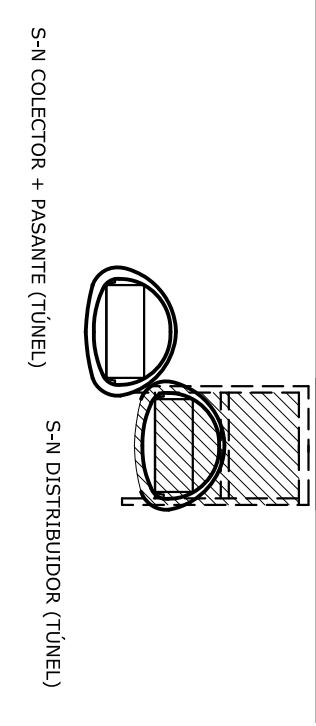
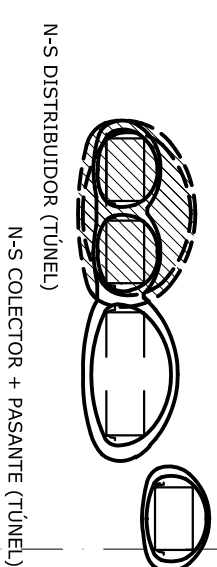
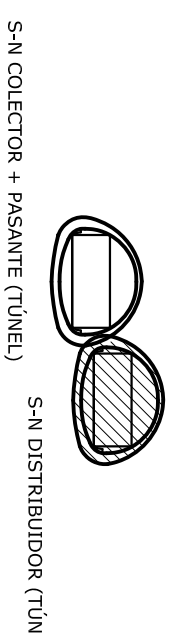
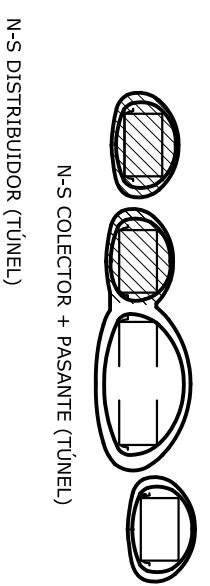

SECCIÓN ENTRE LAVALLE Y TUCUMÁN - TÚNEL / TRINCHERA / C&C

SECCIÓN TUCUMÁN - TÚNEL / TRINCHERA / C&C

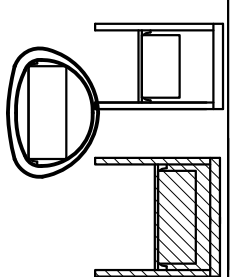
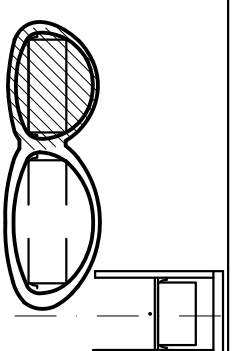
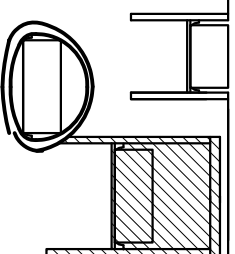
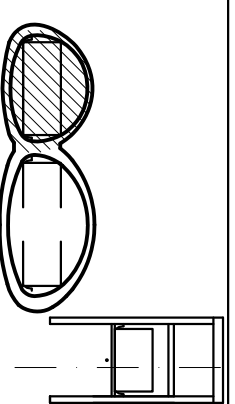

[Handwritten signature]

[Handwritten signature]

REFERENCIAS

ETAPA 2

GOBIERNO DE LA CIUDAD DE BUENOS AIRES MINISTERIO DE DESARROLLO URBANO 		TÚNELES 9 DE JULIO CIUDAD DE BUENOS AIRES		PROYECTISTA: 		E.M. 20/05/09 A.G. 20/05/09 M.F. 20/05/09		ANTEPROYECTO		SECCIONES TRANSVERSALES		Escalas: 1:500 Plano No.: 7/10	
AUSA		0 EMISSION ORIGINAL		MODIFICACIONES		Fecha 05/09 E.N. A.G. M.F.		Dibujo Fecha 20/05/09 E.N. A.G. M.F.		Fecha 05/09 E.N. A.G. M.F.		Fecha 20/05/09 E.N. A.G. M.F.	